

ECONOLINE - DC/DC-Converter

REC2.2-SU and DU Series, 2.2 Watt, DIP24, (Single & Dual Output)

RECOM

Features

- 500VDC Isolation
- High Efficiency
- No Extern. Components Required
- UL94V-0 Package Material



Selection Guide

Part Number DIP24	Input Voltage (VDC)	Output Voltage (VDC)	Output Current (mA)	Efficiency (%)
REC2.2-XX3.3SU	5, 12, 24	3.3	666	72
REC2.2-XX05SU	5, 12, 24	5	400	75
REC2.2-XX12SU	5, 12, 24	12	180	78
REC2.2-XX15SU	5, 12, 24	15	150	80
REC2.2-XX24SU	5, 12, 24	24	92	80
REC2.2-XX3.3DU	5, 12, 24	±3.3	±333	72
REC2.2-XX05DU	5, 12, 24	±5	±200	75
REC2.2-XX12DU	5, 12, 24	±12	±90	78
REC2.2-XX15DU	5, 12, 24	±15	±75	80
REC2.2-XX24DU	5, 12, 24	±24	±46	80

Specifications (Core Operating Area) and Operating Temperature / Derating-Graph

Input Voltage	±10%
Output Accuracy	±5%
Line Voltage Regulation	1.2%/1%V Input
Output Power	2.2 Watt max.
Load Voltage Regulation (10% - 100% Full Load)	±10%
Ripple and Noise (20MHz limited)	100mVp-p max.
Efficiency at Full Load	70% min.
Isolation Resistance (Viso = 500VDC)	10 GΩ min.
Isolation Capacitance	100pF min./1.2nF max.
Isolation Voltage	500VDC min.
Short Circuit Protection	Short Term
Switching Frequency at Full Load	31kHz min. / 85kHz max.
Operating Temperature	-25°C to +70°C (see Graph)
Storage Temperature	-55°C to +125°C
Package Weight	Single type 12.2g Dual type 12.3g

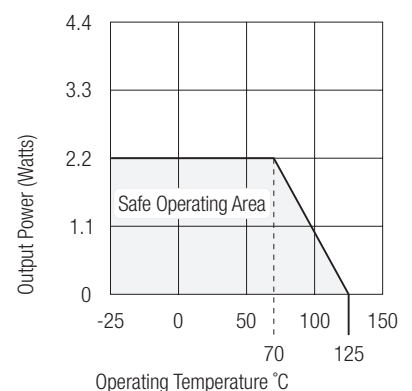

ECONOLINE - DC/DC-Converter

REC2.2-SU and DU Series, 2.2 Watt, DIP24, (Single & Dual Output)

RECOM

Package Style and Pinning (mm)

24 PIN DIP Package

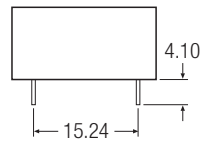
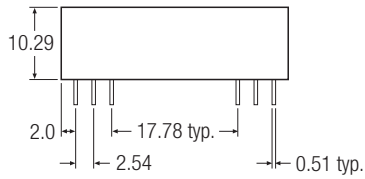
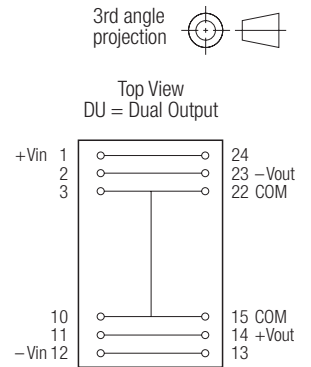
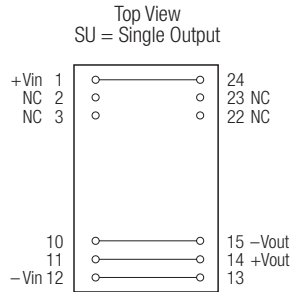
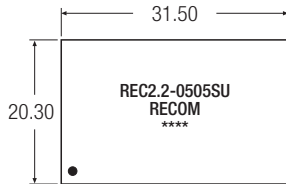

Recommended Footprint Details

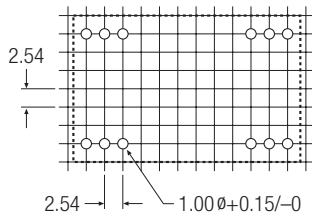

XX.X ± 0.5 mm
XX.XX ± 0.25 mm